

## **Motocross and Quad Rules Regulations**

### **Asia Zone 1 Race**

In order to familiarize with General Competition Rules and other Racing Regulations before any attempts to use BMC Race Track or register for Racing Events, we ask new and existing BMC members to run through updated reminder of Rules and Regulations

- A. BMC Racing Groups - **Season 2018/2019**
- B. Compulsory Safety Equipment
- C. Recommended Safety Equipment
- D. Racing Flags
- E. Race Rules - Cadets & Juniors
- F. Race Rules - 65, 85, 125,240,450 & Open Class
- G. Competition Numbers
- H. Scrutineering
- I. BMC General Rules
- J. BMC Code of Conduct
- K. BMF Supplementary Regulations
- L. BMC Technical Regulations
- M. Protest

Group	Age
Stroke max wheel size 21" front 19" rear 250cc, 450cc Two stroke or four stroke mix wheel size 21" front 19"rear	17+ years
Open Class – 600cc Two Stroke or 650cc Four Stroke Max wheel size 21" front 19" rear 17+ years 1. No Rider is eligible to compete before	17+ years







### **Race schedule 2018/2019**

Asia Zone One	25/01/2019

Clerk of the course: Isa AL Awadhi

1. No Rider is eligible to compete before his / her 5<sup>th</sup> birthday unless Special permission granted by BMC committee following a written application
2. Riders age as of the 1<sup>st</sup> September
3. Mixed Classes of racing will be at BMC Discretion taking into account number of entries and other safety aspects
4. A rider may upgrade to the next class, or remain in the current class, by a maximum of one year only by application in writing to the BMC Club Committee
5. A rider may upgrade to the next class during the season once he / she reaches the required age of that class Once the upgraded the rider cannot return to the original class Championship points from the original class will be frozen once the class upgrade has taken place
6. BMC Committee will take into account Riders past performance, Age, Physical Size, Riding Ability and may even require the BMC Training Officer to grade the rider before sanctioning a class upgrade



**B- BMC COMPULSORY SAFETY EQUIPMENT**

	Gloves
	Long Pants
	Long Sleeve Shirt
	Leather Hi Ankle Shoes for Cadets & Juniors; 65cc and above must have correct Motocross Style Riding Boots
	Handlebar Crossbar Padding
	Correct size motocross Helmet wild eye catching graphics/ consider Safety Ratings DOT, ECE22.02,Snell2010,
	Correct Eye Protection

## C- BMC RECOMMENDED SAFETY EQUIPMENT

	Kidney Belt
	Competition Riding Boots
	Knee Guards
	Elbow Guards
	Body Armor including Shoulder Protection
	Motocross Race Shirt and Pants
	Handlebar Protection Padding

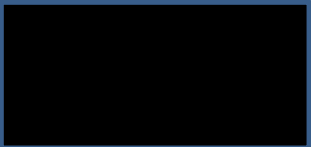
## D- BMC RACING FLAGS

	<p><b>START</b> BHR National Flag dropped from raised position</p>
	<p><b>RACE or PRACTICE STOPPED</b> When Red Flag is displayed, all competitors must slow down, must not overtake and must continue slowly back to the Pits or to the area indicated to them by Officials of the Event</p>
	<p><b>RIDER MUST STOP AT THE PIT</b> When Black Flag with the black Board with a rider number on the board is held stationary, Rider with the indicated number on the board must stop at the Pits on the next Lap</p>
	<p><b>DANGER-DRIVE SLOWLY-DO NOT OVERTAKE</b> When Yellow Flag is held stationary; means Danger, drive slowly and do not overtake When Yellow Flag is waved; immediate danger ahead, slow down and prepare to stop if needed, do not overtake</p>
	<p><b>Clear - Track</b> When green Flag is waved; means danger is cleared you can go full speed</p>
	<p><b>FINISH OF RACE</b> When Chequered Flag is waved; the race is finished</p>

	<p>FINAL LAP Last lap Board</p>
<p>Non Compliance with Flag instructions may result in exclusion from Race Results</p>	

It is compulsory for all Classes to display the BMC logos at the top of the front and both side competitions numbers For Junior Classes it is compulsory to display the BMC logos on the front and both sides of the competition bike near the Competition number, space permitting

Competition numbers will be issued as per top 5 positions for all Classes All other numbers will be allocated on a first come basis

Riders have option to replace BMC issued Competition numbers with others of their choice as long as the numbers chosen comply with guidelines issued in BMC GCR, page 17, [FONT TYPE](#) Competition number plate sizes for Cadet, Junior and 65cc classes are as follows: height=110 mm, width=110 mm, font height=90mm, font type as per FIM rules, [click here to view](#)

Competition number plate sizes for 85, 125 and Open classes will be as per FIM regulations, click to view [PLATE SIZE](#), [FONT SIZE](#), [FONT TYPE](#)

All Classes will have white background and black numbers

Due to both Junior and senior 125cc Classes riding together the following will apply with regard to Competition number allocations:

Number 1 and 2 are reserved for the Junior and senior 125cc

Champions Number 1 will go to either Champion that has the greatest overall point tally in the previous year Number 2 is then the other Champion's number regardless of other competitors overall points tally

All Competitors numbers after this will be allocated as per overall points tally regardless of class if the rightful Champion gives up the right to the Number 1 plate then the other Champion has the option of running the Number 1 plate.

## **F- SCRUTINEERING**

1. All machines and protective clothing must be presented for examination No warranty, whether express or implied, arises from and/or by virtue of Scrutineering or any statements made during Scrutineering, as to the satisfactory quality or safety of any machine, protective equipment, is by its very nature a cursory examination only
2. All scrutineer may refuse the rider's entry to the track if they find the rider's helmet, which in their opinion is likely to cause injury, loss or damage to the rider or fail to prevent injury, loss and damage from occurring to the rider
3. Where a rider has more than one machine; all machines must be presented for Scrutineering, rider can use he's machine only Use of father Rider machine on the same Rice is prohibited It is the Competitors of Guardians responsibility to ensure that all equipment is of correct fit, is of satisfactory quality and that all machines are properly maintained and adjusted to suit the prevailing conditions
4. The BMC, its officials and servants accept no responsibility for loss, damage or other liability howsoever caused arising from the Scrutineering operation the scrutinizer's decision on any such inspection is final
5. Machines must be scrutineered at the start of all events the Competitor and Guardian must be present during Scrutineering
6. The scrutineer may stop a rider from competing if in the opinion of the scrutineer, the riders machine or clothing is unsafe or not in accordance with the BMC Rules and Regulations or if the machine or equipment constitutes a danger to others

## **G- BMC GENERAL RULES**

1. To practice on the BMC track without first obtaining BMC approval is a breach of the GCR's and will be dealt with accordingly
2. No animals are permitted entry to the Motocross competitor's area
3. No riding in the pit area
4. DO NOT DUMP ANY OIL, FUEL OR ANTIFREEZE (COOLANT) on the ground in the pit area, use appropriate catch containers and dispose of your waste correctly
5. Please, clean your area before you leave and take your rubbish with you don't expect the volunteers to clean up after you
6. Dangerous riding will not be tolerated
7. All penalties will be imposed at the discussion of the BMC Officials/Committee with the consent of the BMF with regards to all GCR's, Codes of Conduct and Supplementary Rules.

## **H- BMC CODE OF CONDUCT**

### **Officials Code of Conduct**

- 1- Be consistent and objective at all times
- 2- Understand the purpose of the rules of competition
- 3- Be co-operative and understanding in the interpretation and application of rules or any penalties
- 4- Make a **personal** commitment to keep informed of sound officiating principles and rule updates
- 5- Ensure behavior is consistent with the principles of good sporting behavior  
Actions speak louder than words
- 6- Condemn unsporting behavior and promote respect for all Competitors

### **Competitors Code Of Conduct**

1. At all times you must comply with the Bahrain in Motocross General Competition Rules as well as the supplementary rules of Competition which you participate.
2. You are responsible for your own conduct as well as the conduct of any person associated with you including volunteer team members, mechanics and team managers 3 Most officials give their time freely to ensure that meetings are conducted efficiently and that rules are applied fairly You should avoid public argument with officials If you disagree with a decision, you should approach the official quietly to determine how the decision was reached
3. Verbal and / or physical abuse of officials or other competitors and deliberately distracting or provoking others, whether on or off the track, is not acceptable or permissible behavior
4. Treat all competitors in a respectful and courteous manner
5. Avoid the use of derogatory or coarse language
6. Compete within your skill level Only try to extend these skills when there is no likelihood of danger to any other person, and **personal** risk is controlled
7. At all times follow all reasonable directions given by meeting officials that are within the framework of the BMC GCRs and supplementary rules of competition in which you are participating

## **I- Parent/Guardian Code of Conduct**

1. Encourage children to participate, if they are interested Do not force any child who is not willing to participate
2. Focus upon the child's efforts and performance rather than the overall outcome of the race 3 Assist the child to set realistic goals based on his/her ability
4. Teach children that an honest effort is as important as victory, so that the result of each race is accepted without undue disappointment
5. Encourage children to follow the rules and any official's decision
6. Never ridicule or scold a child for making a mistake during competition Positive comments are motivational
7. Remember children are involved in motorcycling for their enjoyment, not yours
8. Children learn best from example Applaud good performance by all competitors
9. Respect an official's decision if you disagree with an official, raise the issue through the appropriate channels do not question the official's judgment/honesty in public
10. Support all efforts to remove verbal and physical abuse from sporting activities
11. Recognize the importance and value of volunteers they give up their time to provide recreational activities for your children and deserve your support
12. Demonstrate appropriate social behavior by not using foul or derogatory language

## **J- BMC SUPPLEMENTARY REGULATIONS**

### **These Regulations cover the entire BMC Motocross Championship**

#### **1- ANNOUNCEMENT:**

The BMC, hereafter called the PROMOTER will conduct BHR Motocross Championship 2015 - 2016 for Cadets, Juniors, 65cc, 85cc, 125cc, juniors, 125cc seniors, and Open Class, From November 2015 to April 2016

#### **2- JURISDICTION:**

2.1 The above-mentioned Championship has been authorized by the BMF and is open to current BMC members with valid BMF Competition License

2.2 The championship will be held in accordance with the current General Competition Rules and, these Supplementary Regulations

BY ENTERING THIS MEETING AS PART OF THE CHAMPIONSHIP ALL PARTIES AGREE TO COMPLY WITH THESE RULES, REGULATIONS AND INSTRUCTIONS

#### **3- ENTRIES:**

3.1 Entries will be accepted on day of competition



- 3.2 In the case of postponement or abandonment of the meeting, all or any part of the entry fee may be retained by the [Club or Promoter whichever is applicable]
- 3.3 Only entries received on the official Entry Form that is accompanied by the correct fee will be accepted 34 NOTE:  
LATE ENTRIES WILL NOT BE ACCEPTED AND THE RETURN OF ENTRY FEES FOR ANY RIDER WITHDRAWING FROM THE MEETING IS AT THE DISCRETION OF THE [CLUB OR PROMOTER - WHICHEVER IS APPLICABLE]

#### **4- INSURANCE:**

- 4.1 BMF will provide cover for marshals only during the BMC championship events
- 4.2 It is strongly recommended that competitors take out [personal](#) accident, death and permanent disability [insurance](#)

#### **5- MEDICAL SERVICES:**

BMC will endeavor to have a Basic Medical ambulance in attendance during the race meeting

#### **6- ENTRY FEE:**

- 6.1. Entry fee of 10 BD per event for a single entry and a family entry fee of 30 BD per event are applicable
- 6.2. Payment by [Cash](#) is the only acceptable method
- 6.3. Refer to GCRs for non-member fees

#### **7- ENTRY PASSES:**

Payment of entry entitles one competitor and 1 crew free entry into venue

#### **8- CLASSES OF COMPETITION:**

Cadets, juniors, 65cc, 85cc, 125cc juniors, 125cc Seniors, 250cc, 450cc seniors and Open Class

#### **9- AWARDS AND PRIZE MONEY:**

Trophies will be awarded to 1st 2nd and 3rd place in all classes and all other competitors in the cadets, juniors and 65cc classes will be presented with a memorial medal for each round of the championship in the 85cc, 125cc junior / senior And open class's 4th, 5th and 6th positions will also receive memorial medals for each round of the championship

#### **10- ENTRIES TO CONSTITUTE A CLASS:**

- 10.1. To constitute a Class, the number of contestants entered and competing in each Class shall be not less than 4 competitors
- 10.2. Should there be insufficient entries in any Class of Competition, the decision to run or cancel the Class, or to Combine events and re-distribute any awards will be at the Discretion of the BMC Club, subject to EMSF approval

#### **11- RACE FORMAT:**

Cadets, juniors and 65cc Classes will race over a 10minute

Time frame last lap will be shown during the last minute of the Race

85cc Class will race over a 12 minute time, last lap will be

Shown during the last 30 seconds of the race

All other classes will race over a 20 minute time frame with

The last lap be declared during the last 30 seconds of the race

## **12- MACHINES AND RIDERS:**

12.1 All machines entered must comply with the current BMC

General competition rules

12.2 A Rider may change machines provided the machine has

Passed Scrutineering and the event organizer has authorized

The change

12.3 Only 2 machines may be ridden for the duration of one race

12.4 Riding in the pit area are strictly forbidden

## **13-RIDING NUMBERS:**

13.1 Refer to BMC general competition rules for riding number

Allocation procedure

13.2 All Number Plates on all Machines MUST comply with the BMC

## **14- GRID POSITIONS:**

As per the BMC general competition rules

## **15- RIDERS BRIEFING:**

A Riders Briefing will be held prior to the commencement of

Practice and ALL Competitors MUST attend the Riders

Briefing Details will be included in Final Instructions

## **16- DRUG AND OR ALCOHOL TESTING:**

All competitors and officials are advised that [drug](#) and alcohol

Testing may take place at any championship in accordance

With local and government laws

## **17- CODE OF CONDUCT:**

All Competitors, Officials and Parents are reminded of the

BMC - CODE OF CONDUCT (as stipulated in the BMC GCR's)

This is a guide to appropriate behavior at all Motocross Race

Meetings This CODE OF CONDUCT applies to this

Championship and will be enforced

## **18- TIMETABLE:**

Refer to the BMC general competition rules for a detailed

Timetable for each championship event

For the purposes of [drug](#) & alcohol testing, the

Commencement of the meeting will be deemed to be 8:30am

With the completion of the meeting for the participant being

When the participant has vacated the venue

## **19- STARTS:**

The start procedure will be as per the general competition

Rules

**20- RACING:**

A detailed description of race procedure and times are Included in the BMC general competition rules

**21- NOISE:**

Noise emissions must not exceed 102 dB from any single Competition bike

**K- BMC TECHNICAL REGULATIONS**

Capacity:

85cc, 125cc & Open Classes

85cc Class = maximum of 85cc will be allowed

125cc Class = maximum of 125cc 2 Stroke or

250cc 4 Stroke will be allowed

450cc 4 Stroke or 250cc 2 Stroke

Open Class = maximum of 500cc 2 Stroke or 650cc

4 Stroke will be allowed

**Weights:**

85cc = 65kgs Minimum

125cc = 88kgs Minimum

Open = 98kgs Minimum

Motorcycles will be weighed with empty fuel tanks, without rider and safety gear and with correct coolant and oil levels.

The following technical regulations apply to all senior classes

**Engine:** Capacity of the engine will be calculated by the geometric formula, which gives the volume of a cylinder

Any form of forced induction is prohibited

The engine must not continue to run when the throttle control is closed.

**Carburetor:** The carburetor is free only ambient air may be mixed with fuel as an oxidant

**Exhaust:** Exhaust systems must fulfill the requirements of noise control

The exit of the exhaust silencer must exit towards the rear of the motorcycle

**Brakes:** All Motorcycles must have at least 2 functional brakes (one on each wheel)

The brake lever if pivoted on the footrest axis must work under all circumstances, such as a bent or deformed footrest

**Chassis:** A safety guard must be fitted to the countershaft sprocket

All handle bar levers must in principle, be ball ended (diameter of this ball to be at least 16mm)

Each handlebar lever must be mounted on an independent pivot

The repair by welding alloy handlebars is prohibited

The throttle control must be self-closing when not held by the hand

Footrests must be the folding type and must be fitted with a device, which will automatically return them to the normal position

Motorcycle stands must be removed for competition use

Mudguards must project laterally beyond the tire on each side

The ends of the mudguards must be rounded with a radius of not less than 8mm and not exceeding 60mm

**Wheels:**

Cadets = maximum of 12" front and 10" rear

Juniors = maximum of 15" front and 12" rear

65cc = maximum of 15" front and 12" rear

Cooling

**System:**

Air or fluid cooled is permitted

Carburetors: Cadets - maximum diameter of 19mm is permitted

Juniors - maximum diameter of 24mm is permitted

65cc – maximum diameter of 24mm is permitted

Brakes: All classes must have 2 efficient brakes (one per wheel)

Cadets and juniors must have centrifugal clutches with one drive ratio only

Drive train 65cc must have a mechanical clutch with at least 3 forward ratios

Fuel Only ambient air may be mixed with the fuel as an oxidant

Chassis Footrests may be the folding type but in this case must be fitted with a device, which will automatically return them to the normal position

If footrests are not the folding type they must be covered with rubber and have no sharp edges

Motorcycle stands must be removed for competition

A safety engine cut off switch must be mounted on the handlebars

Exhaust: Exhaust is free provided it fulfils the noise requirement control and exits towards the rear of the competition bike.

**L- PROTESTS**

1. Any Competitor has the right to protest a result, other competitor's actions and other competitor's machinery
2. Protest must be in written form and handed to a BMF Official within 30 minutes of the provisional results being posted on the notice board
3. The written protest must be lodged with the appropriate protest fee, which shall not be returned if the protest is judged unfounded
4. Competitors may appeal against decisions arising from protest to the BMF in writing The BMF decisions will be final and not subject to appeal
5. Protest fees:
  - a. To protest an incident a fee of **50 BD** per incident is applicable
  - b. To protest a component of a competition bike a fee of **20 BD** per component is applicable
  - c. To protest a complete competition bike a fee of **100 BD** is applicable
  - d. If the protest is upheld then the fee will be refunded to the Claimant
  - e. The protest fee will not be returned to the Claimant if the protest is unfounded
  - f. The expenses incurred by work and transportation of the competition bike shall be Bourne by the Claimant if the protest is unfounded, or by the Competitor whom the protest is lodged if the Claimant is upheld
  - g. If the protest is unfounded and if the expenses incurred by the protest are higher than the amount of the protest fee, the difference shall be bourne by the Claimant Conversely if the expenses are less the difference shall be returned to them.

### **Delayed Starts**

The start of a race will only be delayed for a maximum of 3 minutes due to a rider's

### **Mechanical difficulty**

A rider may start the race after the official start only if 25% of race time has not been

Completed (for example the late starter must be on the circuit before 2 minutes 30 seconds

Have been completed in any of the junior class races) The Racetrack entry / Exit Marshal shall direct the late rider onto the track at the first safe opportunity to do so; the rider must obey the marshal's directions

### **Leaving track during competition**

If a rider leaves the designated track during a race he/she may only rejoin the race at the Point that he/she exited the track or any safe point prior to the exit point

## Points

Points will be awarded in the following way, per heat / per rider / per class The rider having

The highest points per event will be classified the winner of that event for that class

Serial	Points	Serial	Points	Serial	Points	Serial	Points
1st	<b>25</b>	6th	<b>15</b>	11th	<b>10</b>	16th	<b>5</b>
2nd	<b>22</b>	7th	<b>14</b>	12th	<b>9</b>	17th	<b>4</b>
3rd	<b>20</b>	8th	<b>13</b>	13th	<b>8</b>	18th	<b>3</b>
4th	<b>18</b>	9th	<b>12</b>	15th	<b>7</b>	19th	<b>2</b>
5th	<b>16</b>	10th	<b>11</b>	15th	<b>6</b>	20th	<b>1</b>

For each round of the BMC championship, or other race days, if the above point's tally

Creates a tie then the rider that obtained the highest place in the final heat will be classified the winner In the event of a tie in any of the BMC overall championships, the winner will be the rider with the most number of race wins during the championship If both riders have the same amount of wins then a tally up of second place will take place, this procedure will carry on through the results until a champion is declared If this procedure still does not decide a winner then the rider with the highest place in the last race will decide the winner

## Senior Classes Start Procedure

Riders will report to starting area 5 minutes before schedule start time. Starting Gate positions will be allocated as per championship point standings (see note below). Once inside the starting area the riders are under starter's orders and the following will be the start procedure.

1. 15 Second Board Shown
2. 5 Second Board Shown
3. At any point in next 5 seconds the Starting gates will be dropped to indicate start of Race.

Note: - for the first race of the season Starting Gate positions will be drawn from a hat.

## **Race Time**

65cc Class will race for 15 minutes plus 1 Lap all other classes will ride 20 minutes plus 1 lap, except the MX1 Class that will race for 30 minutes plus 1 lap. All Classes will be shown the last lapboard as close to the last 30 seconds of the race as possible.

The Timekeepers decision is final. The Timekeeper may choose to alter race distance due to circumstances or conditions.

## **Assistance**

For all classes except 65cc and 85cc, absolutely no outside assistance whatsoever will be allowed, except to remove the motorcycle from the track for safety reasons. (See definition of outside assistance on page

5) The Penalty for this offence is exclusion from the race.

## **Jump Starts**

After the Second jump-start the offending rider will be held for 30 seconds before he / she will be allowed to start the race.

## **Finish Classification**

To classify as a finishers rider must cross the finish line and receive the checkered flag, he / she also must complete 50% of the winners race distance.

A Rider may push his / her machine across the finish line without any assistance to classify as a finisher.

The only exception to this is 65cc riders who will be allowed one only assistant in pushing his /her machine across the finish line. A race is deemed finished 3 minutes after the checkered flag is shown, any riders not crossing the finish line in this time will be deemed to have retired from the race.

## **Rules and Regulations – Quad Class**

### **Classes**

450cc and above single cylinder 4 stroke and Up to 350cc two cylinder

2 stroke Race

Together

### **Age Groups**

The Minimum age to be able to compete in the Pro Quad Class is 18

Years as of September

1st each year

### **Engine Capacities**

The maximum engine capacity for a two stroke engine quad shall not exceed 350cc, and be no more than two cylinders

The maximum capacity for a four stroke engine quad shall not exceed

700cc and be no more Than one single cylinder

Tolerances

The actual engine capacity of a machine competing in a capacity class is not to exceed the prescribed capacity for that class

## **Fuel**

Fuel must:

- Be Unleaded
- Be No more than 98 RON
- Contain no additives other than those added at the point of manufacture except for
- Lubricating oil for two stroke engines
- Be readily available from retail petrol pumps within the BHR

General Frames and Parts

## **M- Quad must have the following:**

- Four wheels at the corners of the machine
- The front wheels must be used for steering and the rear wheels for driving
- There must be a seat for one person and the rider must straddle the seat
- Chain and Sprocket guards are MANDATORY the drive chain must be equipped with
- Shields/covers over the lower chain run and around the rear sprocket and brake disc
- See Diagram 1
- A cover must be fitted that covers at least 30% of the front sprocket (counter shaft
- Sprocket) preventing the rider's hand or foot from being trapped
- Mudguards MUST be fitted over front and rear wheels Mudguards over the front wheels
- But may be cut so as to be at least as high as the top of the front wheels as viewed from the side in the horizontal plane
- Heel Guards must be fitted
- Between the front and back wheels, a frame must be fitted (Nerf bars)  
They must be of closed loop design and not extend beyond a point of the widest Dimensions of the vehicle, measured with a straight edge touching the outside of the front and rear tires The bars must be covered with a material to prevent the rider's feet from going below the bars (material webbing is acceptable)  
The material must be attached to the chassis between the front and rear section of the Nerf bar The Nerf Bars must prevent the rider's legs from touching the rear wheels The Nerf bars must be bolted or welded to the frame and must be close enough to the front and rear wheels to prevent locking together of competitors machines No sharp, protruding or open end tubing is allowed



### **Self-closing throttle**

An engine cut out switch; of lanyard type must be attached to the body

Effective brakes on all wheels

A maximum overall width, including the rear tiers, of 1400mm

A maximum wheel base not exceeding 1500mm

Handlebars, rubber hand grips, handlebar levers

Noise emissions of no more than 102 dB (A)

No sharp or protruding extremities

Glass, mirrors, tail lights and headlights must be removed

Double crash bars of a minimum diameter of 25mm must be fitted at the front and rear

With a tube at the rear protecting the chain wheel and rear disc brake both above and to

The rear See Diagram 1

Bead locks are permitted

### **Tires and Rims**

Front: Max Tiers Size 23 inch

Rear: Max Tiers Size 22 inch

In addition, Sand tiers, Paddle tiers and Snow tires are NOT permitted all tiers fitted to

The machine MUST have a tread Pattern Tread patterns as illustrated at the end of this

Section are NOT permitted

### **Protective Clothing**

As per the Equipment outlined on Page 16 of these GCR's

### **Numbers**

Numbers displayed on the machine must be displayed vertically and of the size as defined in these the GCR's

### **Competition Rules**

Starting

Unless otherwise determined in the SR, massed starts must be used A maximum of 15

Machines will be permitted to start together

The order and position of each competitor will be at the discretion of BMC and will be

Determined on the day of the event

The starting grid for all events will:

- Have not less than two meter space for each quad
- Be in one straight line

**DIAGRAM 1**

Tread patterns not allowed for all quad classes paddle type and any form of sand tires will not be permitted

Tread patterns not allowed for all quad classes paddle type and any form of sand tires will not be permitted

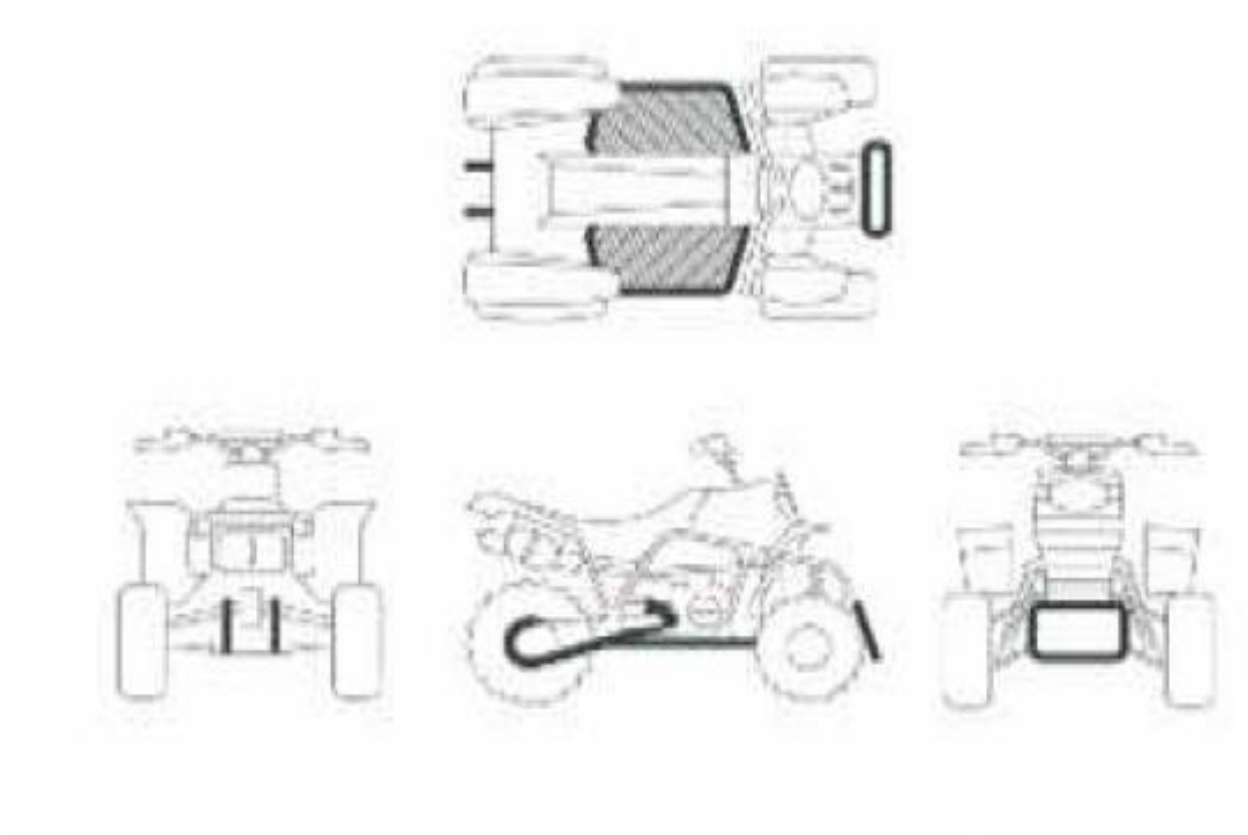

## Offences

### List of Offences

Any promoter, rider or parent / guardian of a rider who is a minor, who:

1. Breaches any of these Rules, or any SR;
2. Acts in a manner which is prejudicial to the sport or breaches the Code of Conduct;
3. Being a promoter advertises, and / or programs riders who have not entered the meeting
4. Being a promoter, club, entrant, or rider knowingly publishes false information concerning the results of any competition
5. Enters, or attempts to enter, any ineligible person, body or machine in any competition
6. Does any act, the direct or indirect purpose of which is to breach or cause to be breached any agreement between any promoter, entrant, or rider in respect of any competition
7. Acts in a reckless or dangerous manner while competing
8. Disobeys the lawful direction, order or requirement of any controlling body or official under these Rules
9. Obstructs or misleads any official in the exercise of any of the powers and duties conferred on that official by these Rules
10. Behaves in an offensive or abusive manner toward any competitor or any official exercising authority under these Rules
11. Assaults any competitor or any official exercising authority under these Rules
12. Participates in any competition for which that person or body has failed to complete an entry form or pay entrant fees
13. Uses other than the prescribed fuel in any competition
14. Fails to comply with the direction of an authorized official to submit to a fuel test under these Rules
15. Being an entrant causes or permits the rider entered by the entrant, or any mechanic or assistant of that rider, not to comply with any of these Rules
16. Being a competitor where any of their mechanics, assistants, team members or in the case of a competitor under the age of
18. Years, their parents, fails to comply with any of these rules
17. Commits a doping offence under BMC Anti-Doping Policy
18. Being an official and knowingly:
19. Signs a record of measurement as a personal record when it was not;
20. Assists in the promotion or conduct of any competition which is not authorized under these rules; or Fails to comply with these rules is liable to be penalized under these Rules

## **Note:**

- Should a member of a rider's team or family breach any of the above rules, the rider may be held responsible 34 The Imposition of Penalties during Events In any event during the course of a meeting, a steward may fine, exclude, impose penalty or time points on, or relegate, any competitor, if:
  - The whole or any part of that competitor's machine has left the track and there by gained an advantage, unless such action was:
  - For the safety of other competitors; or Due to the action of other competitors
  - The competitor has gained an advantage as a result of an unfair start
  - The competitor has been guilty of unfair or unsafe conduct
  - The competitor receives outside assistance other than:
    - By a relevant official at the start of an event; or
    - In the interests of safety, The competitor's machine is dangerous
- The competitor's machine does not comply with the requirements of these Rules or any SR
- The competitor has unreasonably refused to submit to a medical test required by the Steward under these Rules No person may protest against, or appeal from, a decision to impose a penalty during an event For the purposes of this Rule a decision does not operate as such unless and until it is notified to the competitor affected by it or to that competitor's team, providing such notification is practicable within the context of the event Hearing and Determination of Charges during Meetings

In any proceeding relating to the imposition of penalties for offences committed during the Course of a meeting:

- 1 A Steward:
  - May act on their own initiative;
  - May act on such information and in such manner as they think fit having regard to
    - the conduct for which a penalty is to be imposed;
    - Must, in respect of all prosecutions conduct a hearing;
    - Must, as soon as practicable after determining the penalty, inform the competitor and the competitor's team of the penalty imposed; and
    - May not impose any fine greater than the maximum prescribed in by-laws
  - No person may be represented by a legal practitioner 35

## **Penalties**

In imposing any penalty, a Steward, RCB or the appellate body must have regard to the following principles:

No penalty should be imposed unless and until the offender has been given the opportunity to make representations as to the nature

and extent of the penalty; In ordinary circumstances a single penalty should be imposed for a single offence;

The punishment for an offence should be commensurate with the gravity and effects of the offence;

The interests of the sport are paramount;

The severity of penalties imposed on an individual should increase if that individual continues to commit offences against these Rules;

Mitigating factors put by or on behalf of an offender must be taken into account, as must the effects on others of the actions of the offender

A Steward may impose the following penalties for any offence committed under these Rules:

1. A reprimand
2. A fine no greater than **BD 200**
3. Relegation
4. Exclusion
5. Suspension of no more than 6 months

## **Default penalties**

Any person or body having power to impose any fine under these Rules must fix a time within which the fine is to be paid

Tests for Prohibited Substances

A person who commits a doping offence contrary to the BMC Anti-Doping Policy will be sanctioned by BMC in accordance with the policy

Prohibited substances:

Refer to the World Anti-Doping Agencies 2007 Prohibited List

## **Red Flag**

In the event of a race being stopped by a red flag, the results will be taken from the previous lap if two thirds of the race time had been completed before the red flag was shown.

Otherwise the race will restart in its entirety. If one or more riders are deemed to be at fault for the race being stopped, they may be excluded from taking part in the restart. (Excluding jump start issues)

## **Fines**

Fines are payable to the **BMF Office**

### **Suspension and Disqualification**

An order for suspension of any person or body will operate throughout the period thereof

So as to prevent that person or body from participating in any competition

An order for suspension or disqualification from competition may operate so as to prevent from participation in competition a machine or machines of a particular manufacturer provided that no such order may be made unless the appellate body is satisfied that the offence or offences leading to the making of the order were committed with the knowledge, or at the instigation, of the manufacturer or the manufacturer's agent

Any person or body who is the subject of an order of exclusion or an order for suspension or disqualification for any offence committed at, connected with, or arising from, any competition is liable to forfeit the right to receive or retain any award, trophy or prize in respect of that competition<sup>24</sup>

If any penalty imposed alters the result of any competition, the RCB must, as soon as practicable after being notified of the penalty, alter the record of that competition so as to reflect the alteration

Note: The Race Director has final decision in case of any breach, offence and or violation of any race rule or regulate

